

SFH551/1-1 and SFH551/1-1V

Receiver with Digital Output Stage for Polymer Optical Fiber Applications

Data Sheet



Lead (Pb) Free
RoHS 6 fully compliant



Description

The SFH551/1-1 receiver is a transimpedance amplifier with an integrated photodiode and TTL open-collector output stage. The active area of this detector combined with the molded microlens gives an efficient coupling from the end of the polymer optical fiber. This receiver enables data rates up to 5 MBd and works with the Avago SFH757 transmitter diode.

The SFH551/1-1 is fully DC coupled and therefore no line code is needed. The internal Schmitt trigger ensures stable output states over the whole dynamic range. If light with intensity above the threshold level is coupled into the SFH551/1-1, the electrical output will be logical "low" and vice versa.

With noise-free Vcc and GND, an undefined output signal is not possible. Nevertheless, the SFH551/1-1 must not be used without shielding from ambient light. If ambient light could reach the threshold level, the SFH551/1-1V component should be chosen. The plastic connector housing of the SFH V-series shields the ambient light perfectly.

SFH series components are optimized for easy coupling. No fiber stripping is required; just insert the cut fiber into the selected SFH component.

Ordering Information



SFH551/1-1



SFH551/1-1V

Type	Ordering Code
SFH551/1-1	SP000063860
SFH551/1-1V	SP000063855

Features

- Bipolar IC with open-collector output
- Digital output, full TTL compatible
- Sensitive in visible and near IR range
- Transfer rate ≤ 5MBd
- Low switching threshold
- 2.2mm aperture holds standard 980/1000/2200µm plastic fibers
- No fiber stripping required
- Molded microlens for efficient coupling

Plastic Direct Fiber Connector housing (V-housing)

- Locking screw attached to the connector
- Interference-free transmission by the light-tight housing
- Transmitter and receiver can be positioned flexibly
- No cross talk
- Auto insertable and wave solderable
- Supplied in tubes

Applications

- Household electronics
- Power electronics
- Optical networks

Application Literature

AN #	Description
5342	General information about the SFH series with Selection Guide and recommendations regarding System Planning and Mounting
5341	Information about Basic and Special Circuits for Transmitter and Receiver of the SFH series

SFH551/1-1

The transparent plastic package has an aperture where a 2.2 mm fiber end can be inserted. This coupling method is very easy and extremely cost-effective.

SFH551/1-1V

The V-housing allows easy coupling of unconnectorized 2.2 mm polymer optical fiber by an axial locking screw.

The SFH551/1-1 receiver is a transimpedance amplifier with a TTL open-collector output stage, therefore a pull-up resistor of at least 330 Ω is necessary (see Figure 1). To minimize interference a bypass capacitor (100 nF) must be placed near (distance ≤ 3 cm) the SFH551/1-1 ports. In critical applications a shorter distance is better.

Functionality

The SFH551/1-1 photodiode is silicon based and directly connected to a transimpedance amplifier that works as a pre-amplifier. A differential amplifier is connected in series and works as a post-amplifier. Its output is passed to the internal Schmitt trigger that drives a bipolar NPN transistor. The data-out signal is from the collector of this bipolar transistor.

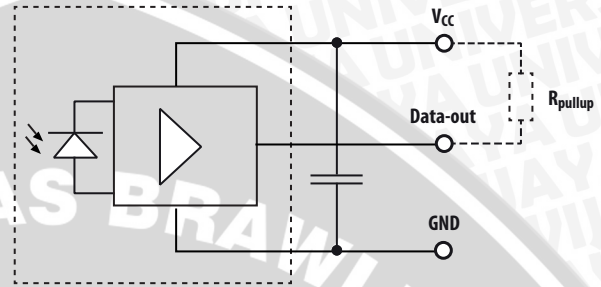
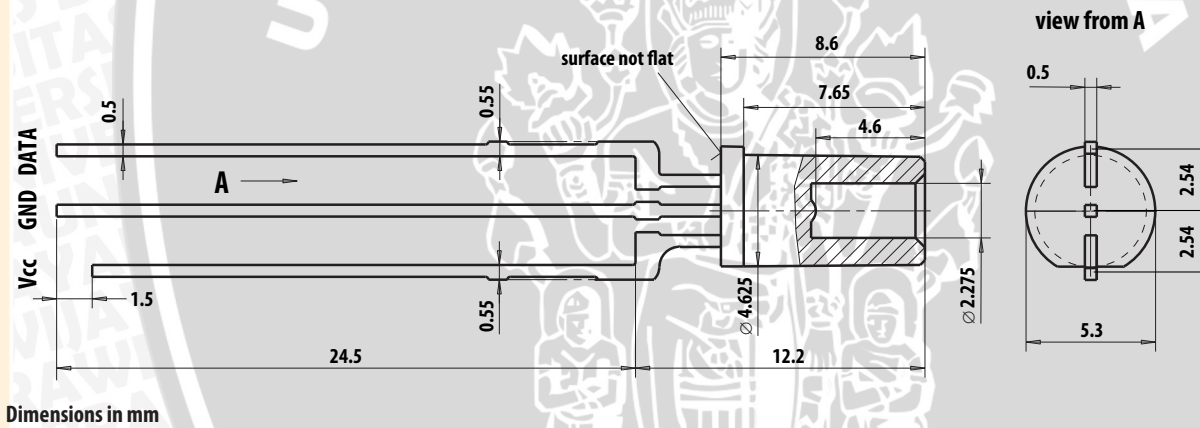

Figure 1. Equivalent circuit diagram (simplified)

Package Dimensions

SFH551/1-1



Dimensions in mm

SFH551/1-1V

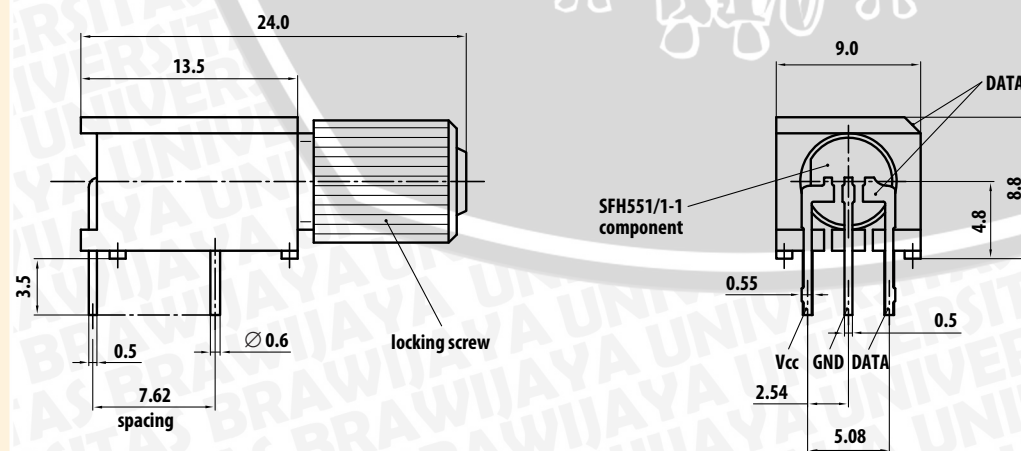

Dimensions in mm

Package V-housing Color

SFH V-series components are color coded just like other Avago fiber optic components. The SFH757V transmitter has a white colored housing; the SFH250V and SFH551/1-1V receiver components have a black colored housing. This prevents mistakes while making connections. Product designation and date of manufacture are printed on the housing.

Package V-housing mounting pins

SFH V-series components have two pins that are electrically isolated from the inner circuit. The pins are only designed for mounting the V-housing to the PCB surface. This helps increase stability, which is needed during fixing the fiber end by the axial locking screw.

The retention force between the soldered mounting pins and the V-housing of the SFH component is about 20 N (with a vertical exertion of force). This is an approximate value.

Package V-housing axial locking screw

Components of the SFH V-series are equipped with an axial locking screw for easy coupling to the unconnectorized 2.2 mm polymer optical fiber. The force that is necessary to pull a jammed fiber out of the V-housing is typically 50 N (with a torque of 15 cNm for tightening the locking screw). This is an approximate value that is very dependent on the fiber and torque combination.

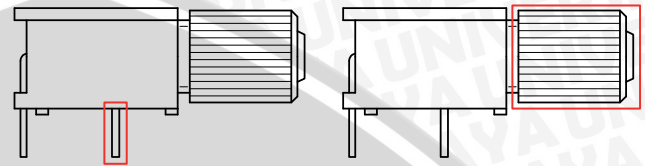

Package V-housing mounting pins

Package V-housing axial locking screw

Technical Data

Absolute Maximum Ratings

Parameter	Symbol	Min	Typ	Max	Unit	Notes	Figure
Operating Temperature range	T_C	-40		+85	°C		
Storage Temperature range	T_{stg}	-40		+100	°C		
Supply Voltage Range without Damage	V_{CC}	-0.5		15	V		
Soldering Temperature (2mm from case bottom, $t \leq 5s$)	T_S			+260	°C		
Minimum Supply Voltage for Function	V_{CCmin}	4			V		
Minimum Pullup Resistance ($V_{CC}=5.0V$)	R_{outmin}	330			Ω		1
Output Voltage	V_O	-0.5		15	V		
Output Current	I_C			50	mA		
Power Dissipation (Output)	P_O			100	mW		
Electrostatic Discharge Voltage Capability	ESD			2000	V		1
Electrostatic Discharge Voltage Capability	ESD			400	V		2

Notes:

1. ESD Capability for all Pins HBM(Human Body Model) according JESD22-A114
2. ESD Capability for all Pins MM (Machine Model) according JESD22-A115

Characteristics ($T_A = -40^{\circ}\text{C}$ to $+85^{\circ}\text{C}$; $V_{CC} = 4.75\text{V}$ to 5.25V) unless otherwise specified

Parameter	Symbol	Min	Typ*	Max	Unit	Notes	Figure
Maximum Photosensitivity Wavelength	λ_{smax}		700		nm		
Photosensitivity Spectral Range ($S=80\%$ of S_{max})	λ_s	600		780	nm		
Mean POF Overdrive Limit: Maximum Input ($\lambda = 650\text{ nm}$)	$P_{IN(max)}$	252 -6	1000 0		μW dBm(mean)	5, 7, 8	4
Peak POF Sensitivity Limit: Minimum Input for Logic "0" ($\lambda = 650\text{ nm}$)	$P_{IN(L)}$	20 -17	6.3 -22		μW dBm	4, 5	
Peak POF Off State Limit: Maximum Input for Logic "1" ($\lambda = 650\text{ nm}$)	$P_{IN(H)}$			0.1 -40	μW dBm	4, 5	
Propagation Delay (Input: Pattern "1010", 5MBd) (Optical Input to electrical Output)	t_{PHL} t_{PLH}			120 270	ns	1, 6	2,3,4
Output Voltage at Logic "1"	V_{OH}	$V_{CC}-0.6$	$V_{CC}-0.3$		V	3	
Output Voltage at Logic "0"	V_{OL}		0.2	0.6	V	3	
Switching times (Input: Pattern "1010", 5MBd) Output Rise time (10% - 90%)	t_r		14	30	ns	2, 3, 6	
Output Fall time (90% - 10%)	t_f		4	15	ns	2, 3, 6	
Current Consumption (Input: Pattern "1010", 5MBd)	I_{CC}	8	14	20	mA	3, 6	
Current Consumption (Logic "1", Light OFF)	I_{CCH}	1.5	3.5	6.5	mA	3	
Current Consumption (Logic "0", Light ON)	I_{CCL}	13	17.5	23	mA	3	

* Typical value = mean value at $T_A=25^{\circ}\text{C}$ and $V_{CC}=5.0\text{V}$

Notes:

1. $PWSFH_output = PW_{opt_input} + (t_{PLH} - t_{PHL})$; PW = pulse width
2. Switching times increase with temperature
3. Measured with recommended $R_{pullup} = 330\Omega$ (see Figure 1)
4. Sensitivity increase with temperature
5. $Value_{dBm} = 10 \cdot \log(Value_{measured} / 1\text{mW})$
6. Limits valid for optical input power from $-20\text{dBm}(\text{mean})$ to $-9\text{dBm}(\text{mean})$
7. $dBm(\text{peak}) = dBm(\text{mean}) + 3\text{dB}$
8. $PWD \leq 170\text{ns}$; Input: Pattern "1010", 5MBd

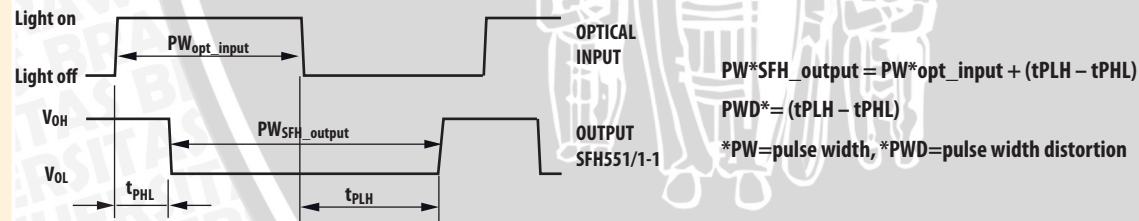

Figure 2. Typical corresponding optical input to electrical output signal

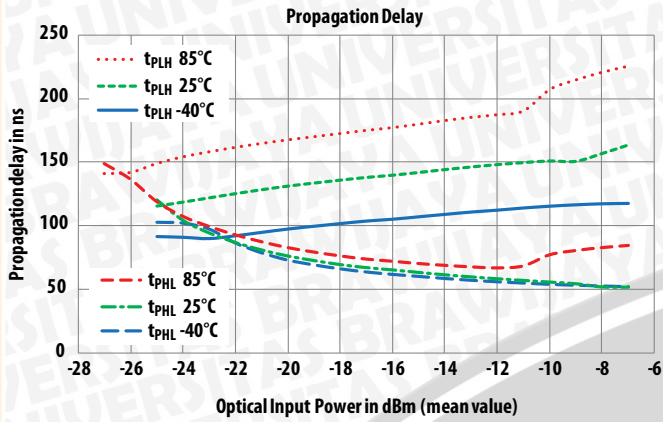

Figure 3. Typical Propagation delay, measured with Pattern "1010" at 5 MBd

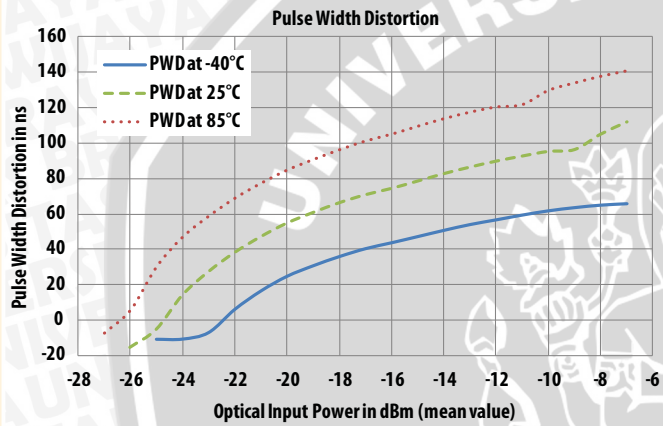

Figure 4. Typical Pulse Width Distortion, measured with Pattern "1010" at 5 MBd

For product information and a complete list of distributors, please go to our web site: www.avagotech.com

Avago, Avago Technologies, and the A logo are trademarks of Avago Technologies in the United States and other countries. Data subject to change. Copyright © 2005-2011 Avago Technologies. All rights reserved. Obsoletes AV01-0713EN AV02-3033EN - October 25, 2011

